

かんじのねんじゆじ

ひらがな

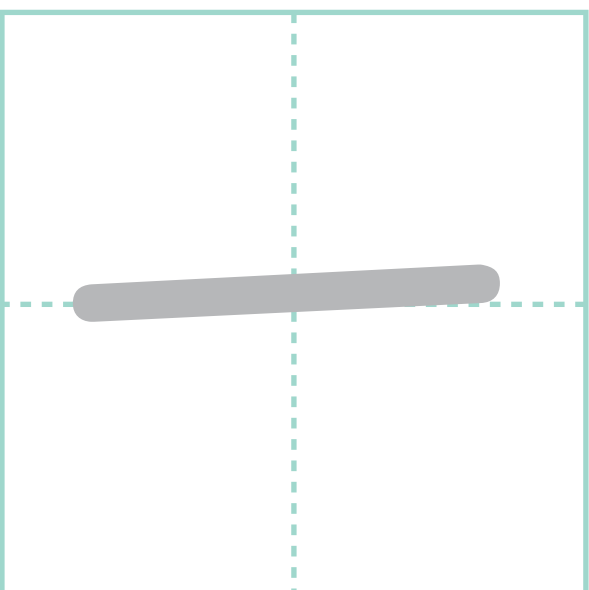

一	い
一	っ
ぴ	び
き	き

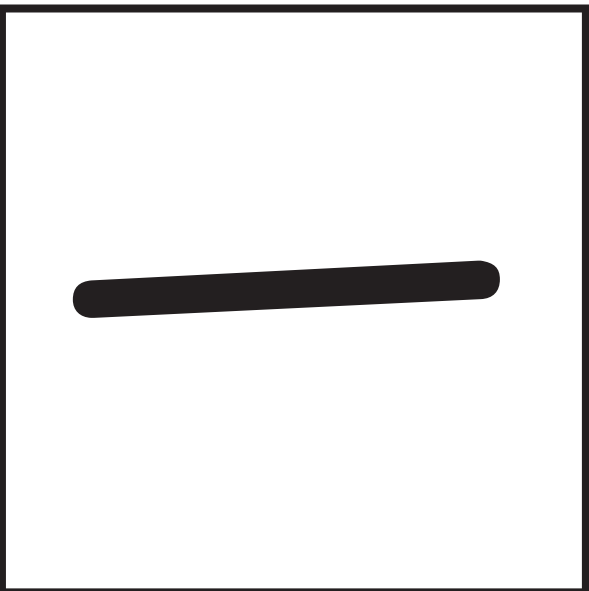

一	いち
り	り
ん	ん
車	しゃ

かんじのねんじゆじ

ひらがな

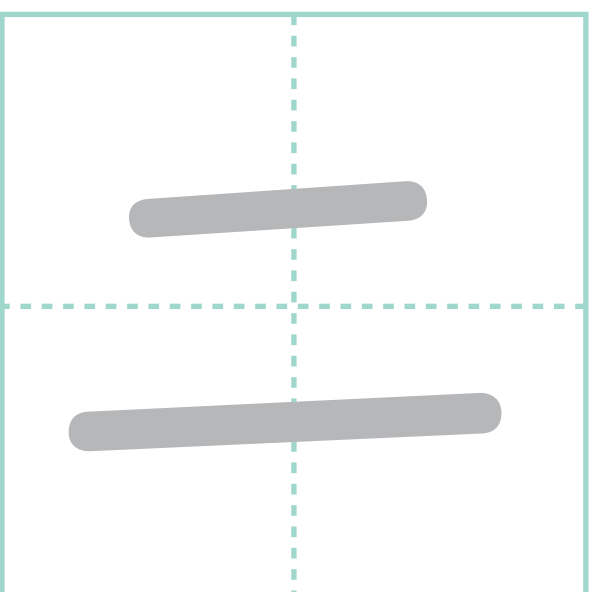
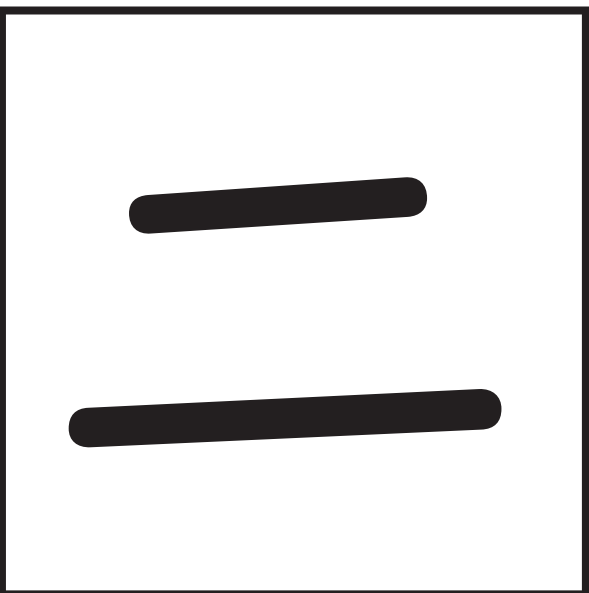

	に
	か
	い



	ふた
	つ

かんじのねんじゆじ

ひらがな

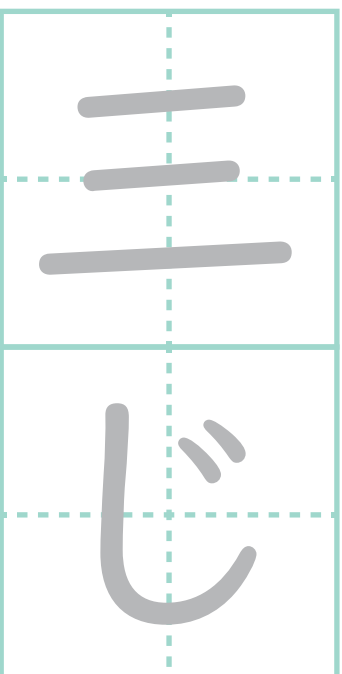
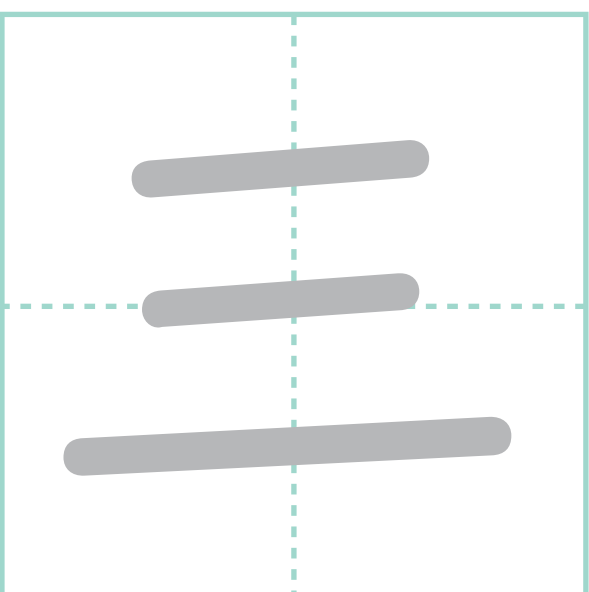
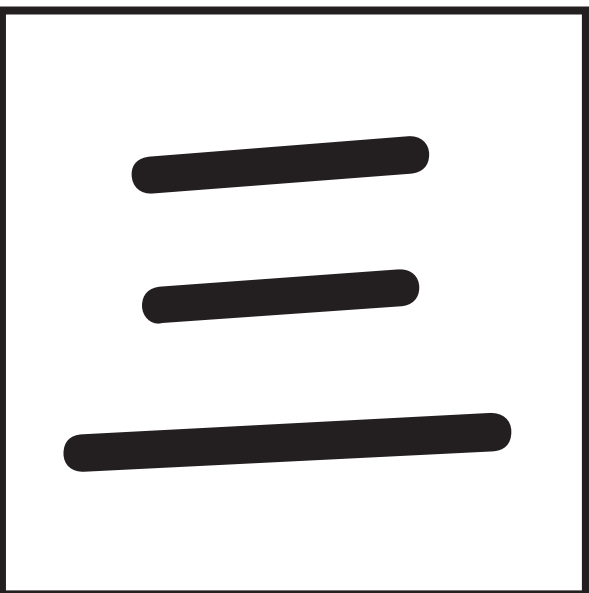

さん

じ

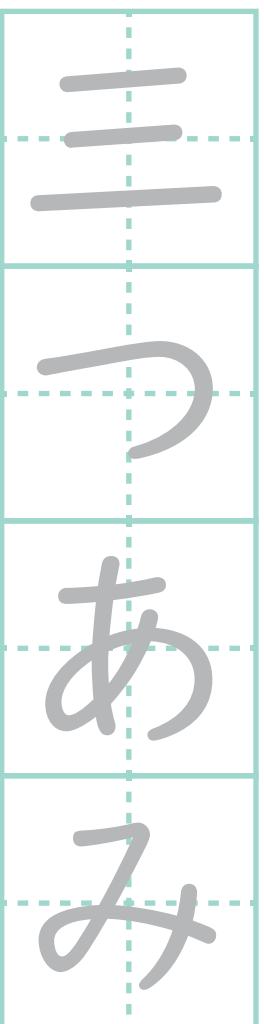

み

つ

あ

み

かんじのねんしゅじ

ひらがな

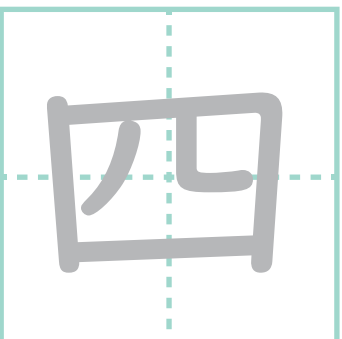
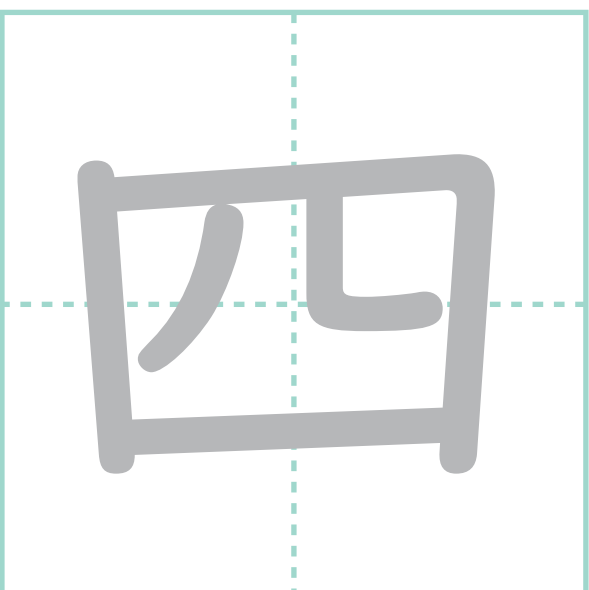
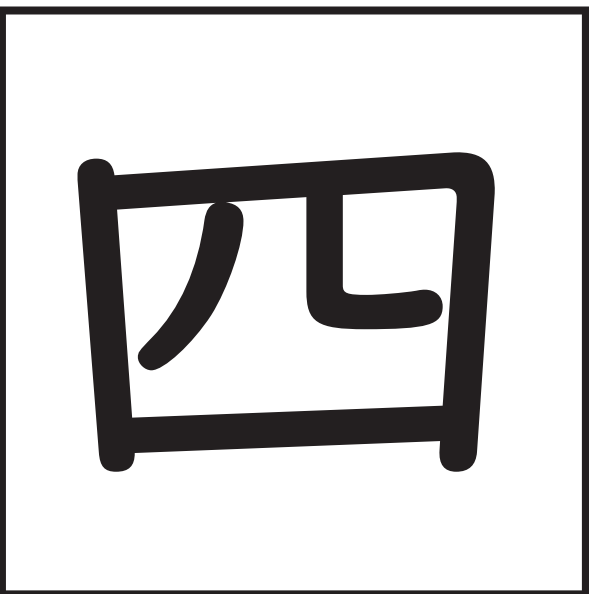

よん

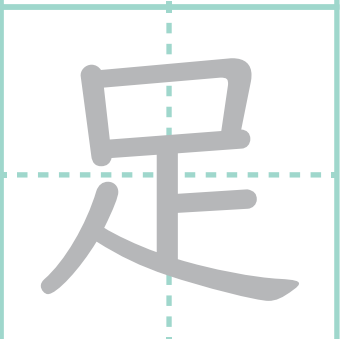

そく

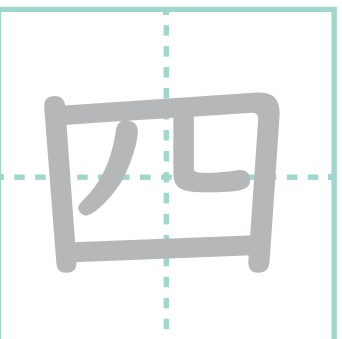

し

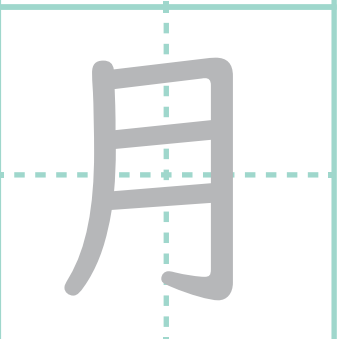

がつ

かんじのねんじゆじ

ひらがな

五

五



しち

ご

さん

七

五

三

ご

えん



五

円

かんじのねんじゅじ

ひらがな

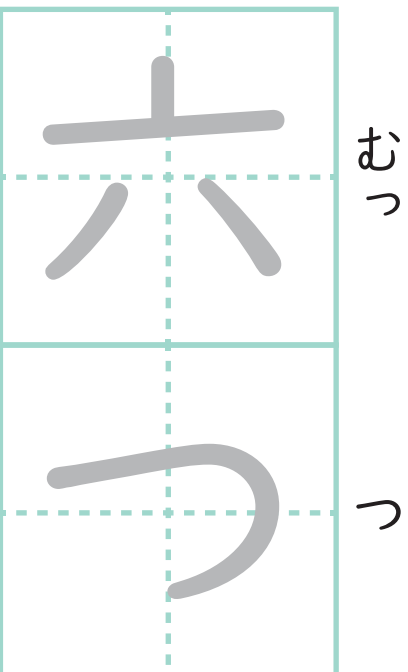
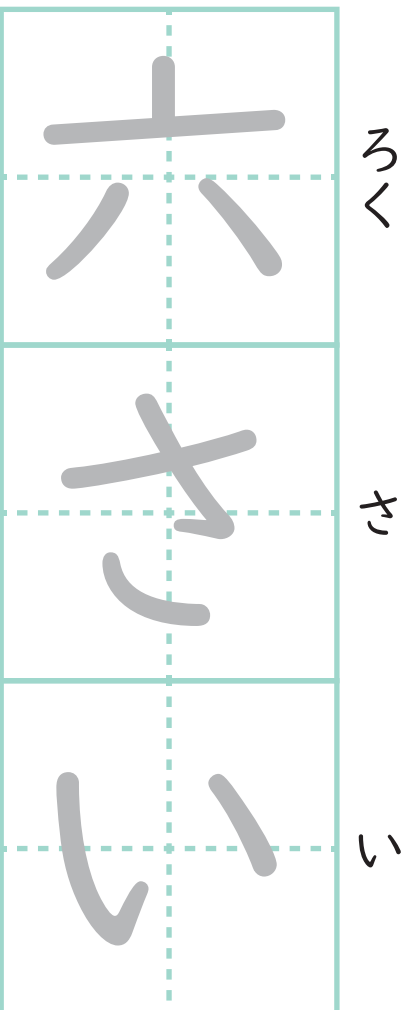
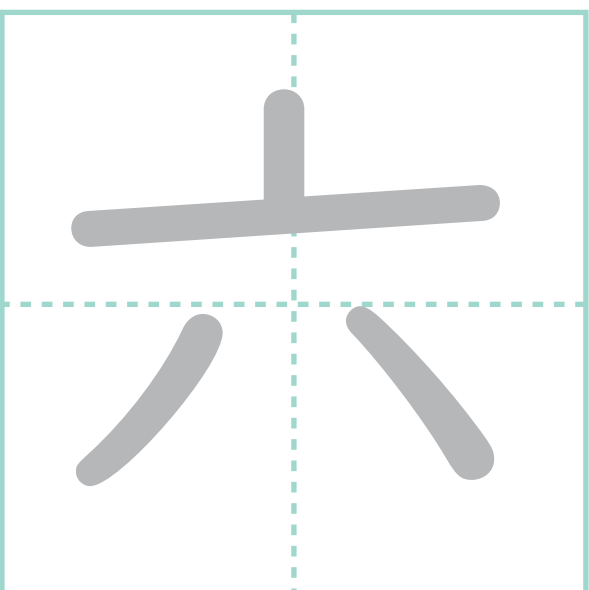

かんじのねんじゆじ

ひしち

七

七



なな

くさ

七

草



しち

ひ

き

七

ひ

き

かんじのねんじゅじ

ひらがな

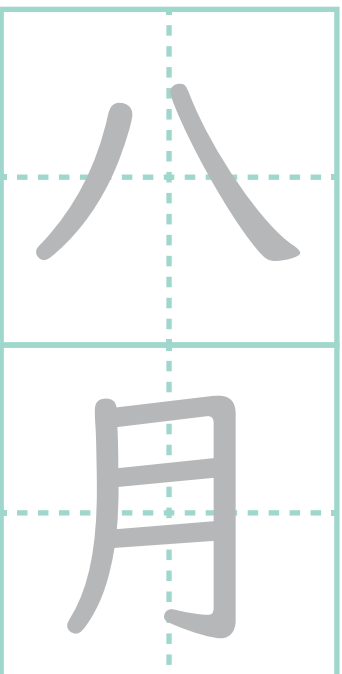
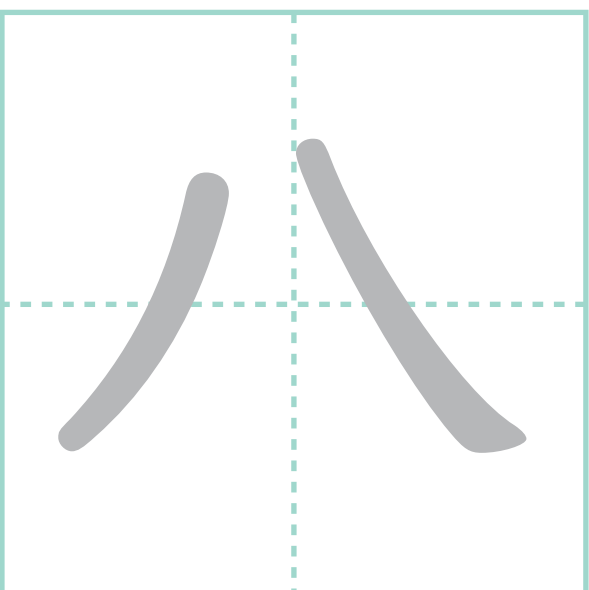

はち

がっ

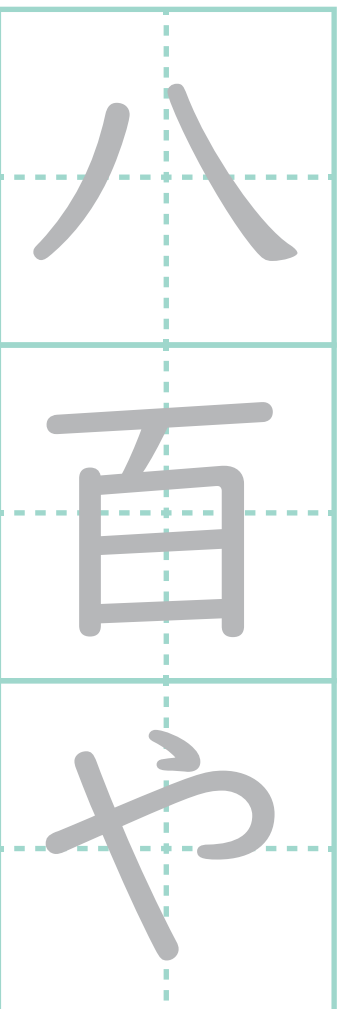

や

お

や

かんじのねんじゆじ

ひらがな

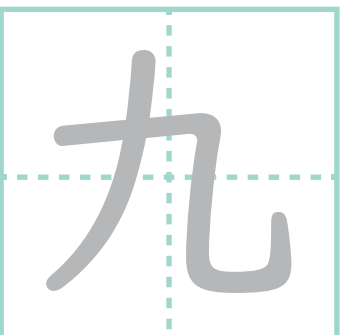
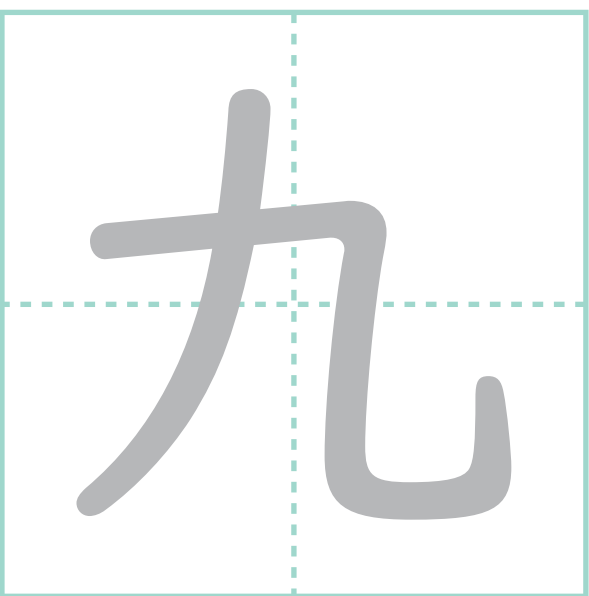

丸の

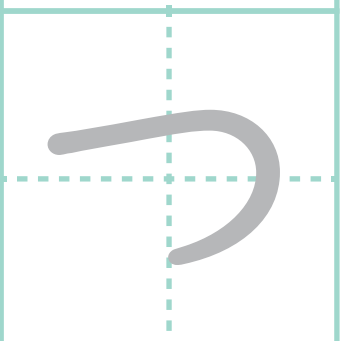

まる

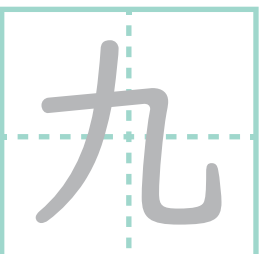

きゆう

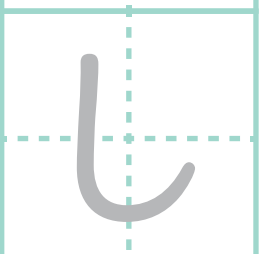

し

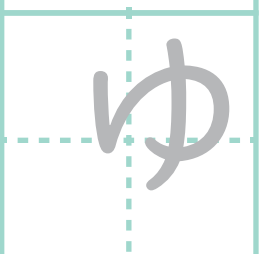

ゆ

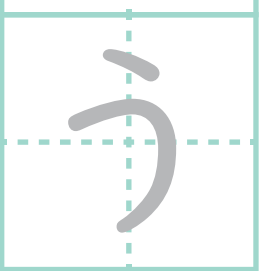

う

かんじのねんじゆじ

ひらかな

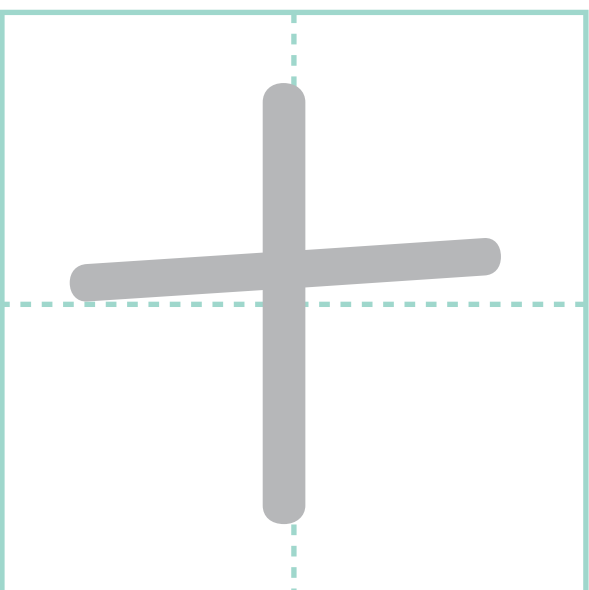
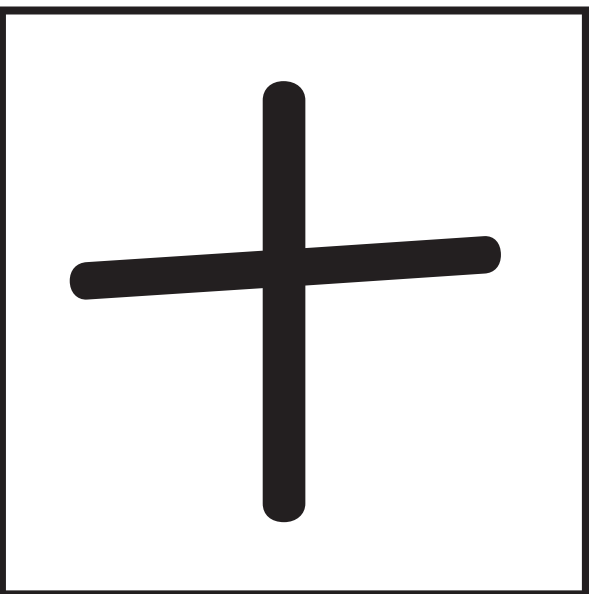

じゅう

がつ

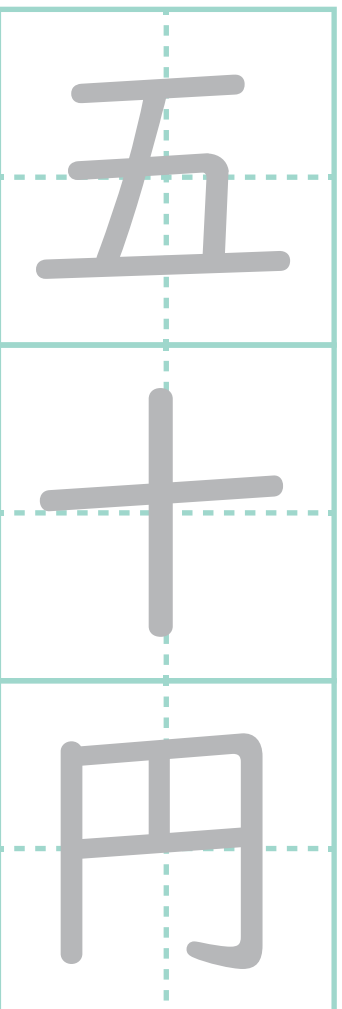
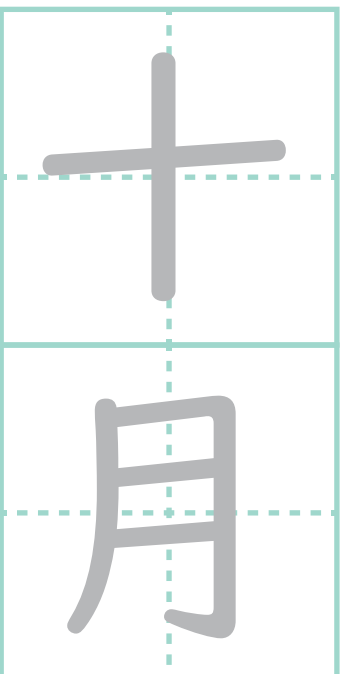

ご

じゅう

えん