

かんじのねんじゆじ

ひらがな

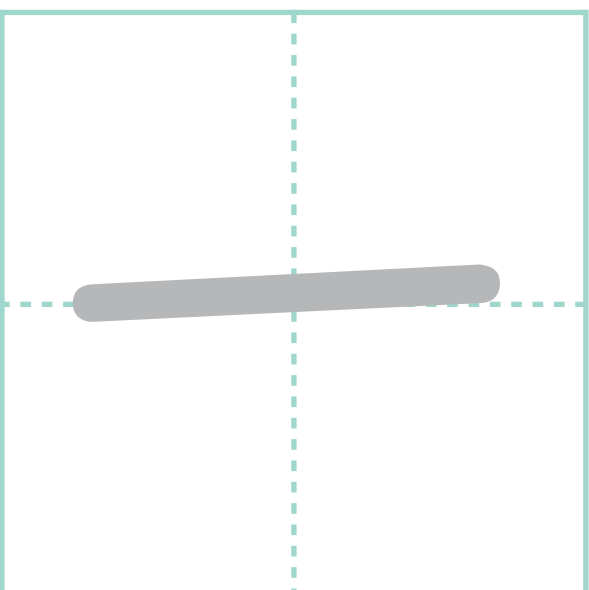
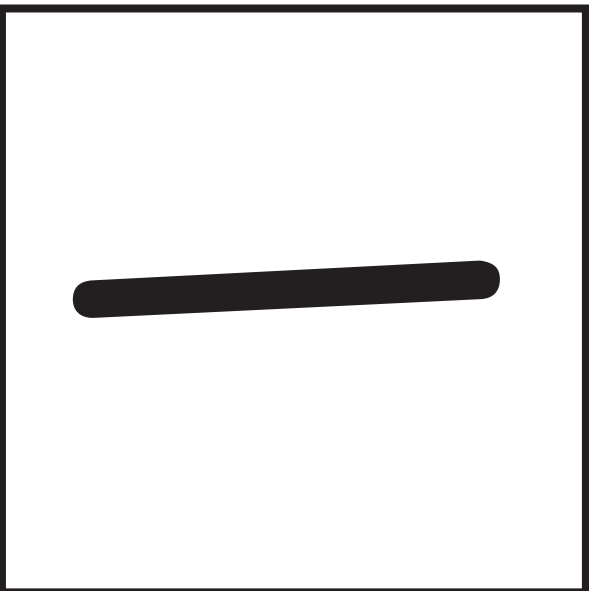

	ひ		
	き		

ひ
き



	り		
	ん		
	車		

いち
り
ん
しゃ

かんじのねんじゆじ

ひらがな

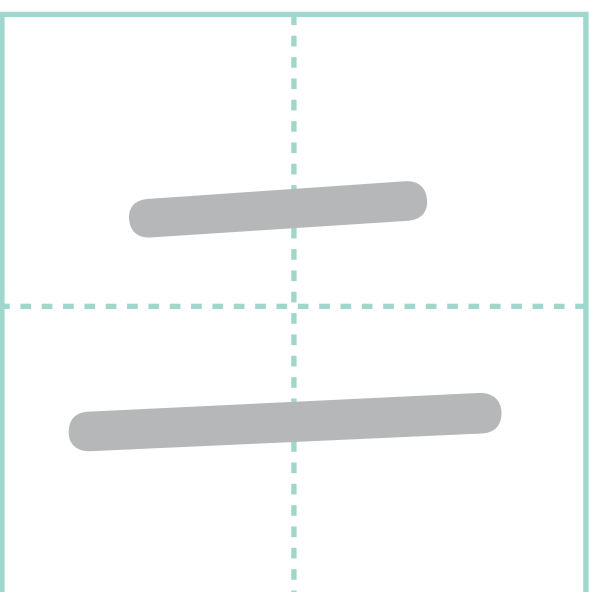
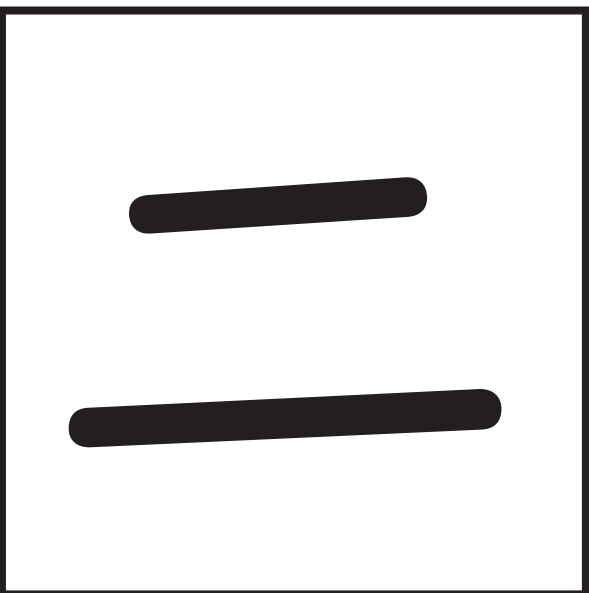

		に
か		か
い		い



		ふた
つ		つ

かんじのねんじゆじ

ひらがな

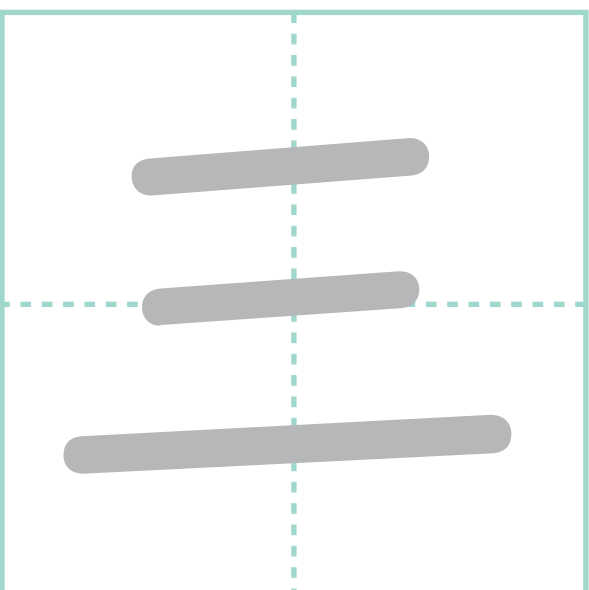
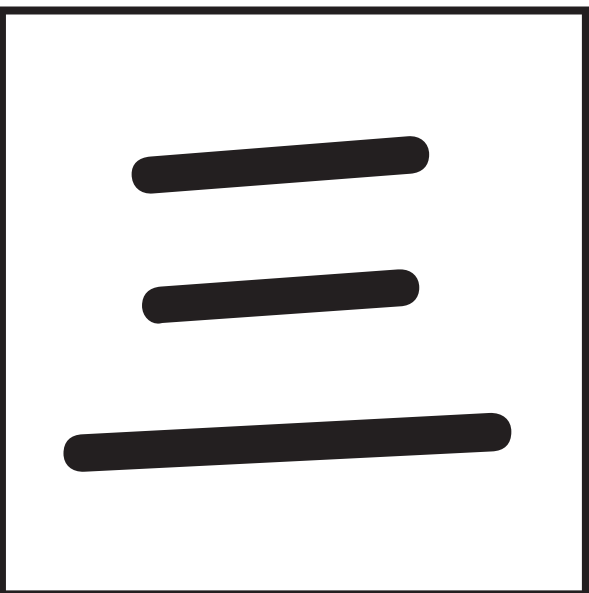

さん

さん

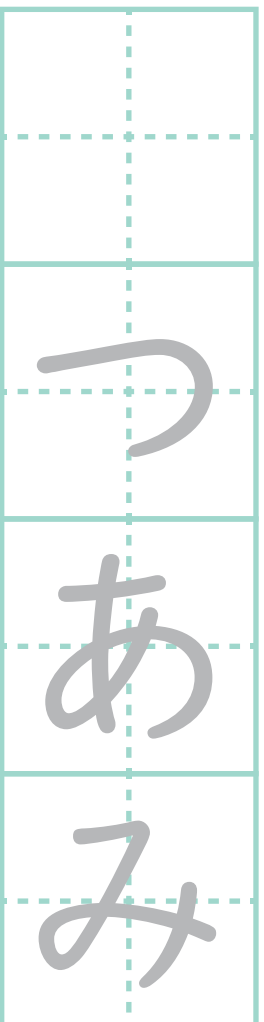
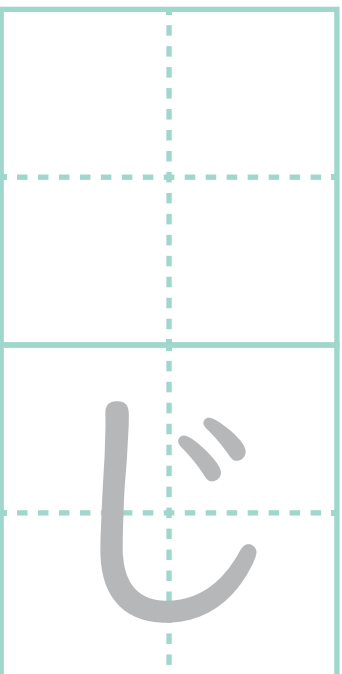

み

つ

あ

み

かんじのねんじゆじ

ひらかな

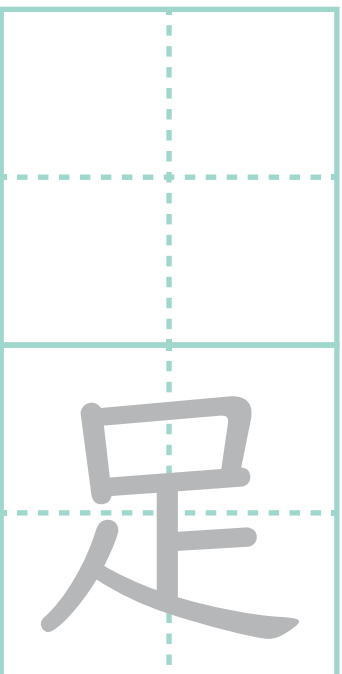
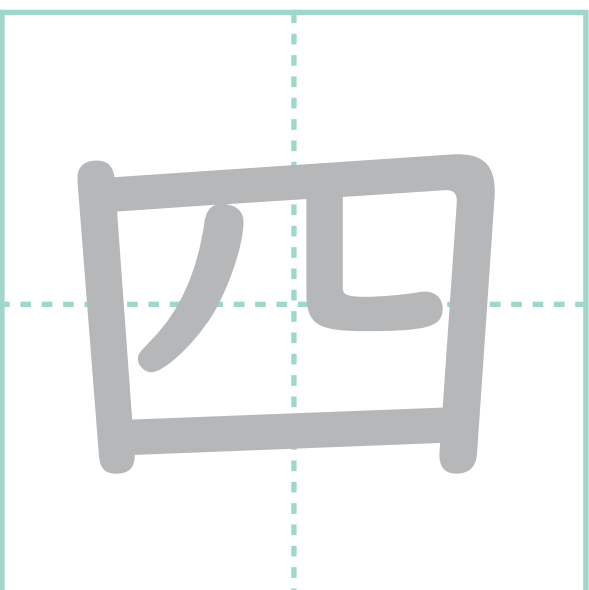
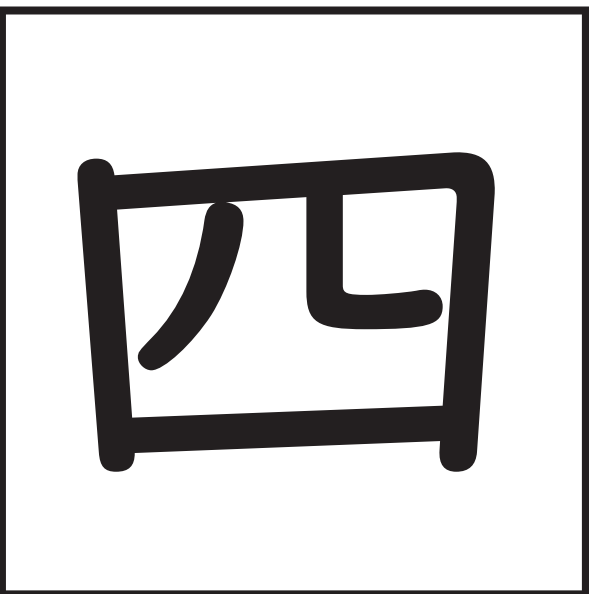

よん

そく

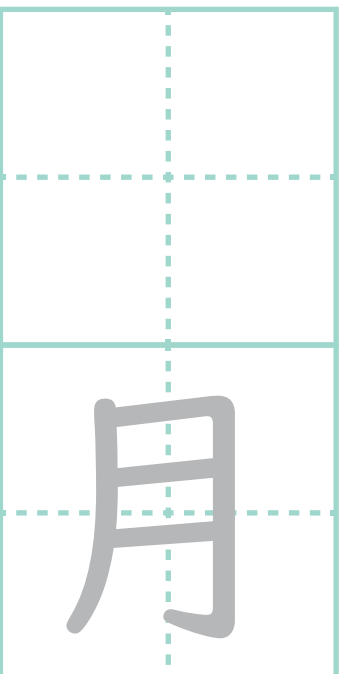

し

がつ

かんのねんしゅじ

ひらがな

五

五

しち

ご

さん



七

三

ご

えん



円

かんじのねんじゅじ

ひらがな

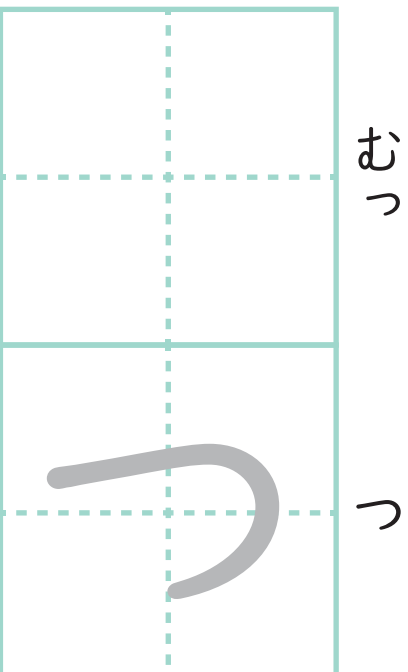
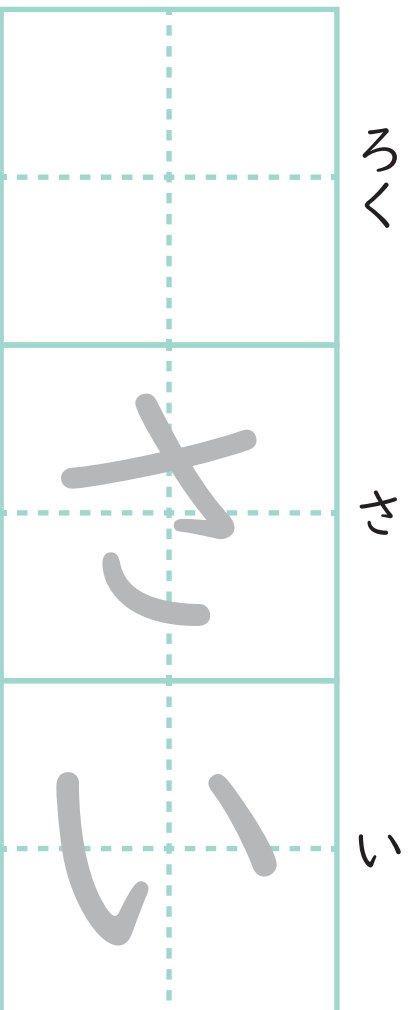
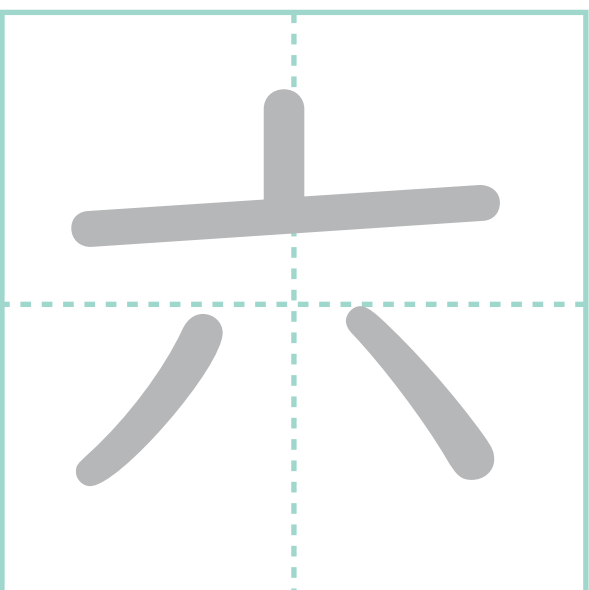

かんじのねんじゆじ

ひしち

七

七



なな

くさ

草



しち

ひ

き

ひ

き

かんじのねんじゅじ

ひらがな

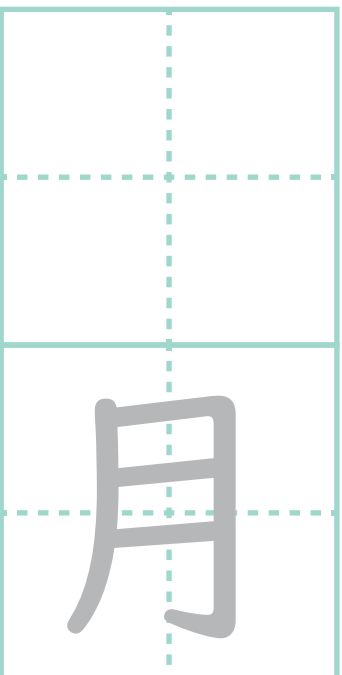
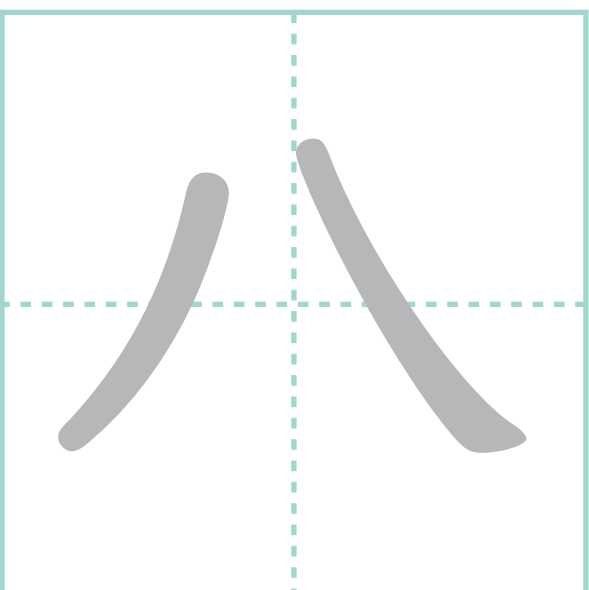

はち

がつ

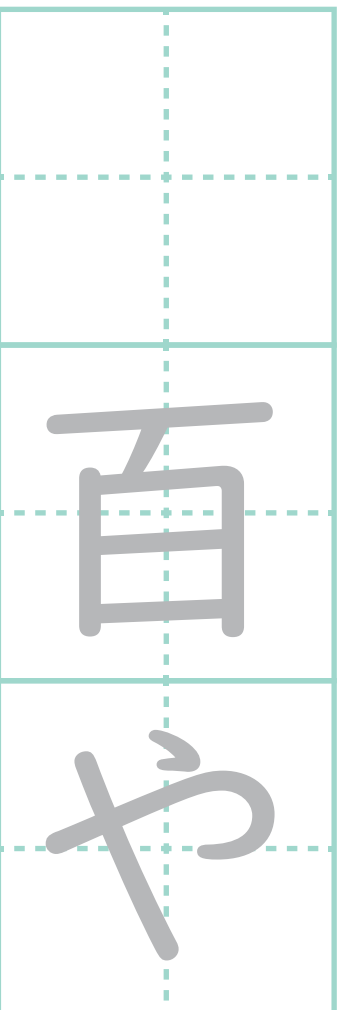

や

お

や

かんじのねんじゆじ

ひらがな

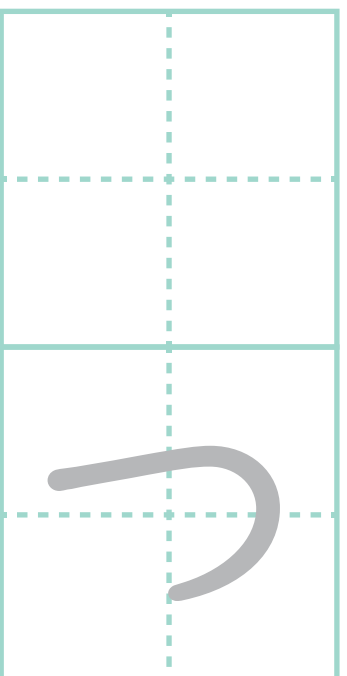
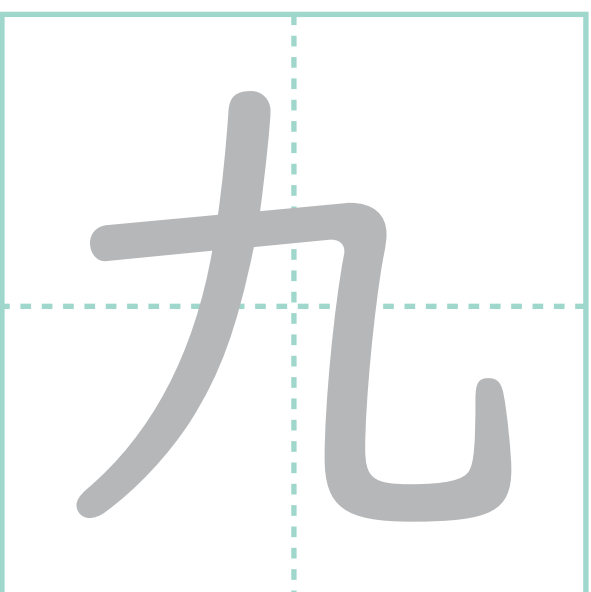
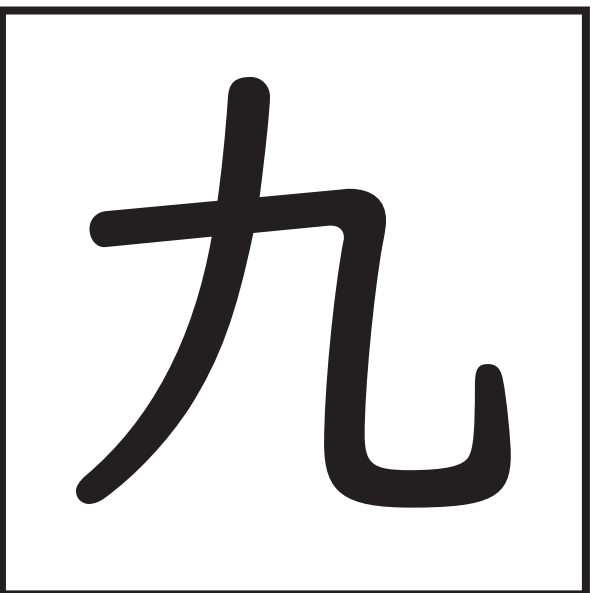

丸

丸

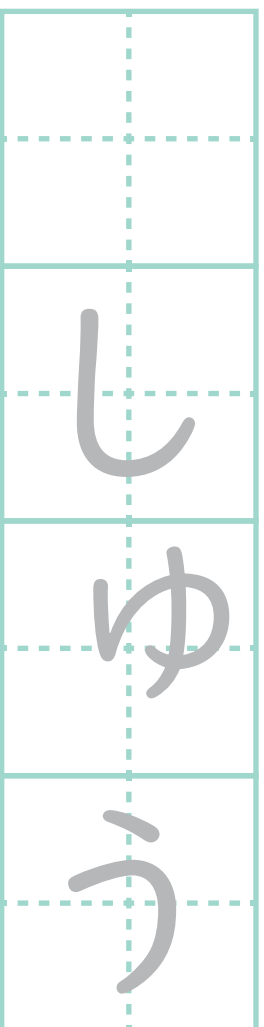

丸

丸

丸

丸

かんじのねんじゆじ

ひらかな

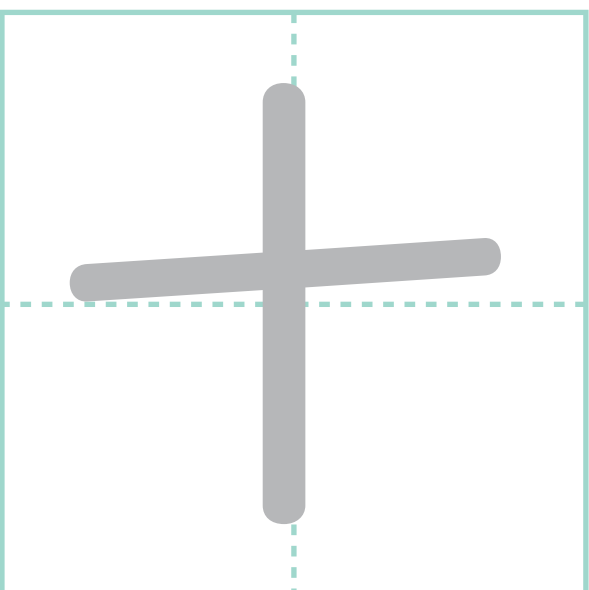
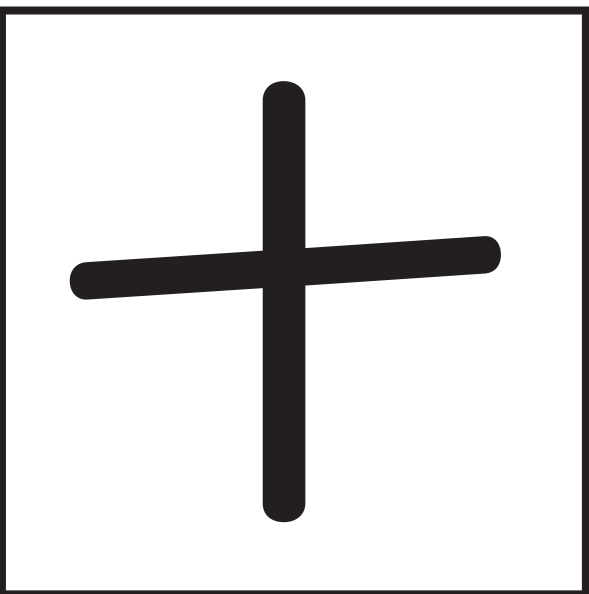

じゅう

がつ

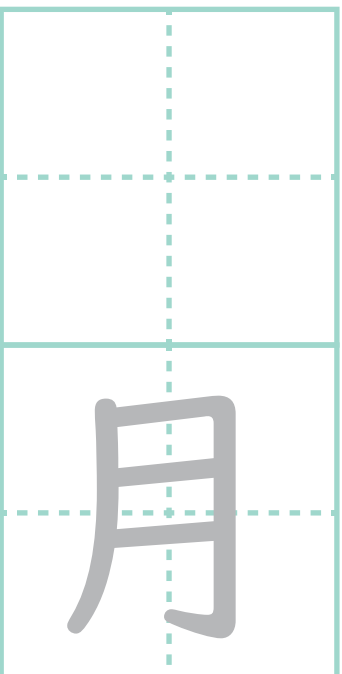

ご

じゅう

えん

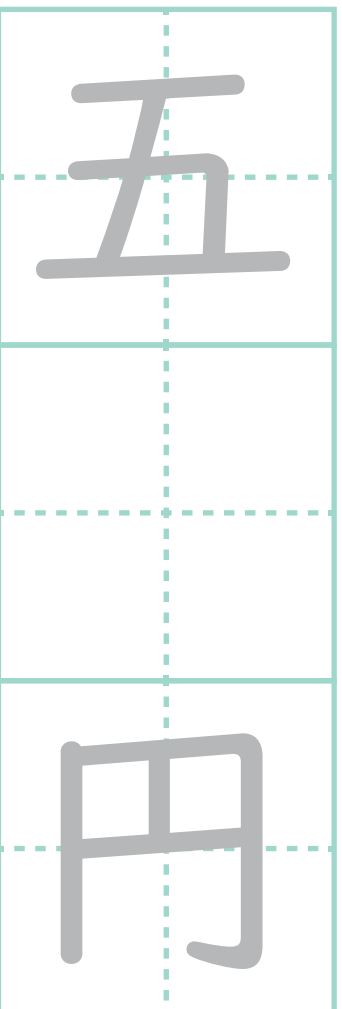

五

円